

AUDIOVOX®
ELECTRONICS CORP.

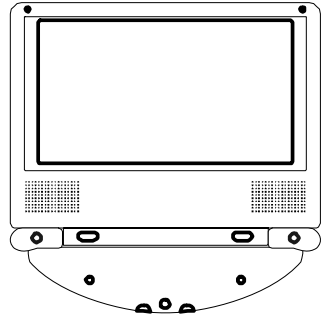

D1788ES

**7" LCD MONITOR, DVD PLAYER
WITH BUILT-IN BATTERY AND EXTRA MONITOR**

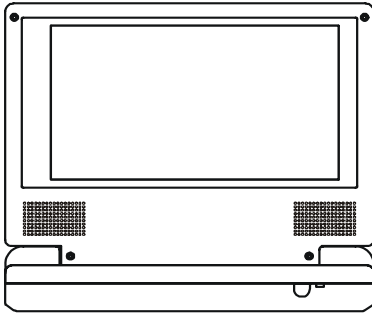

For Customer Service
Visit Our Website At
www.audiovox.com
Product Information, Photos,
FAQ's, Owner's Manuals

Notice:

This Product incorporates copyright protection technology that is protected by method claims of certain U.S. Patents and other intellectual property rights owned by Macrovision Corporation and other rights owners. Use of this copyright protection technology must be authorized by Macrovision Corporation, and is intended for home and other limited viewing uses only unless otherwise authorized by Macrovision Corporation. Reverse engineering or disassembly is prohibited.

Notice:

An LCD panel and/or video monitor may be installed in a motor vehicle and visible to the driver if the LCD panel or video monitor is used for vehicle information, system control, rear or side observation or navigation. If the LCD panel or video monitor is used for television reception, video or DVD play, the LCD panel or video monitor must be installed so that these features will only function when the vehicle is in “park” or when the vehicle’s parking brake is applied.

An LCD panel or video monitor used for television reception, video or DVD play that operates when the vehicle is in gear or when the parking brake is not applied must be installed to the rear of the driver’s seat where it will not be visible, directly or indirectly, to the operator of the motor vehicle.

A. Introduction

Thank you for selecting the D1788ES portable DVD player. The main features include two 7" Wide Screen (16:9 Aspect Ratio) Liquid Crystal Display (LCD) monitors and a DVD player. The unit applies the latest state of the art electronics and is designed for use in hotels, offices home or vehicle. The unit is constructed to provide years of reliable, trouble-free service, and is compact so that you can take it with you anywhere and is designed for quick and easy installation. Please read the entire instruction manual supplied with this product prior to operation. The documentation will assist you in installing the system properly to obtain the best equipment performance. Please save this manuals for later use.

B. Cautions and Warnings

1. Placement

To prevent fire or electric shock, do not expose this appliance to rain or moisture. Do not place the set on an unstable cart, stand, tripod, bracket or table to prevent it from falling. Keep the unit away from strong magnets, heat sources, direct sunlight, excessive dust. If the unit is brought directly from a cold to a warm location, moisture may condense inside the unit. When you move it from a cold to a warm location, wait for about one hour before operating the unit, or remove the disc and leave the unit turned on until the moisture evaporates.

2. Installation

Ensure that the D1788ES is used in accordance with the instructions and illustrations provided in this manual.

3. Objects and Liquids

Do not push objects of any kind into the unit through openings; do not spill or spray liquid of any kind on or in the system (this may result in a fire or electric shock). Do not place anything heavy on the unit. To ensure proper ventilation and proper operation, never cover or block the slots and openings with a cloth or other material.

4. Disassembly

Do not attempt to disassemble the cabinet. There is a risk of electric shock and/or exposure to Laser Radiation. Contact qualified service personnel if your system is in need of repair.

5. Cleaning Unit

When cleaning, make sure the system is unplugged from the power source. Do not use liquid cleaners or aerosol cleaners. Use a cloth lightly dampened with water for cleaning the exterior of the system only.

6. Disc

Do not use irregularly shaped discs such as heart or star-shaped discs as they may cause the unit to malfunction. Do not stick paper, tape or glue on the disc. Do not expose the disc to direct sunlight or heat sources such as hot air ducts. Do not touch the surface of disc. Handle the disc by its edge. Clean the disc by wiping the disc from the center out with a cleaning cloth. Remove the disc from the unit and store it in its case after playing. Some playback operations of discs may be intentionally fixed by software producers. Since this unit plays discs according to the disc contents the software producers designed, some playback features may not be available. Also refer to the instructions supplied with the discs.

7. Regional Coding

Both the DVD player and disc are coded by region. These regional codes must match in order for the disc to play. If the codes don't match, the disc won't play. This unit's code is region 1. DVD's with other regional codes cannot be played in this unit.

C. Contents

1. 1 x 7" LCD Monitor & DVD Player
2. 1 x 7" LCD Monitor
3. 1 x AC to DC Adapters
4. 1 x Remote Control with battery (CR2025)
5. 1 x Instruction Manual
6. 1 x AV Adapter Cable (One to Three Female)
7. 1 x AV Adapter Cable (One to Three Male)
8. 1 x Y Type DC Power Adapter
9. 1 x Mounting Bag With Straps for the Monitor
10. 1 x Carry Bag With Straps

D. Powering and Installation

1. Powering the system indoors (Refer to Figure 1)

Plug one end of the AC to DC adapter into the DC 9-12V jack on the right side of the main unit, then plug the other end into the 100-240V AC power receptacle.

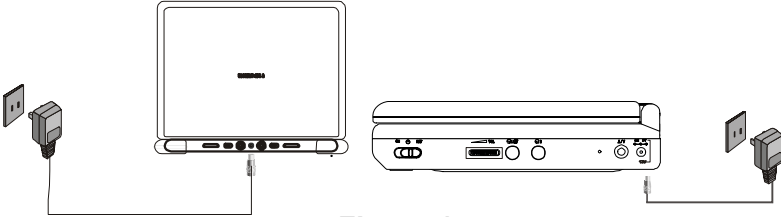

Figure 1

2. Powering the system in a car (Refer to Figure 2)

The DC power adapter has two 9V output plugs. Plug the ends of the DC power adapter output into the DC 9-12V jack on the main unit and the extra screen and plug the input end into the vehicle power socket. Connect the main unit AV OUT and extra screen AV IN with the 2 supplied AV cables as shown.

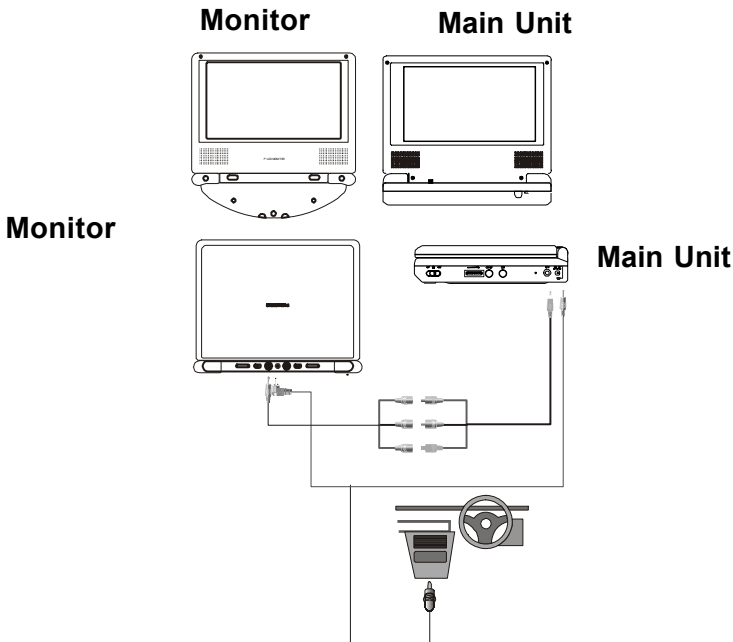

Figure 2

3. Built-in Battery

Plug one end of the AC to DC adapter into the DC jack on the side of the player, then plug the other end into the 120V AC power outlet. Make sure the player is in the “Power Off” mode. Once fully charged, the LED indicator will turn off. Once the indicator is off, remove the AC to DC adapter wall plug.

NOTE: Your new battery must be charged a minimum of 8 hours before the first usage. Each full recharge takes approximately five hours and one full charge can provide power to the player for approximately 2 hours.

E. Vehicle Installation

Installing the DVD Player and monitor onto a car seat

(Refer to Figures 3 through 5)

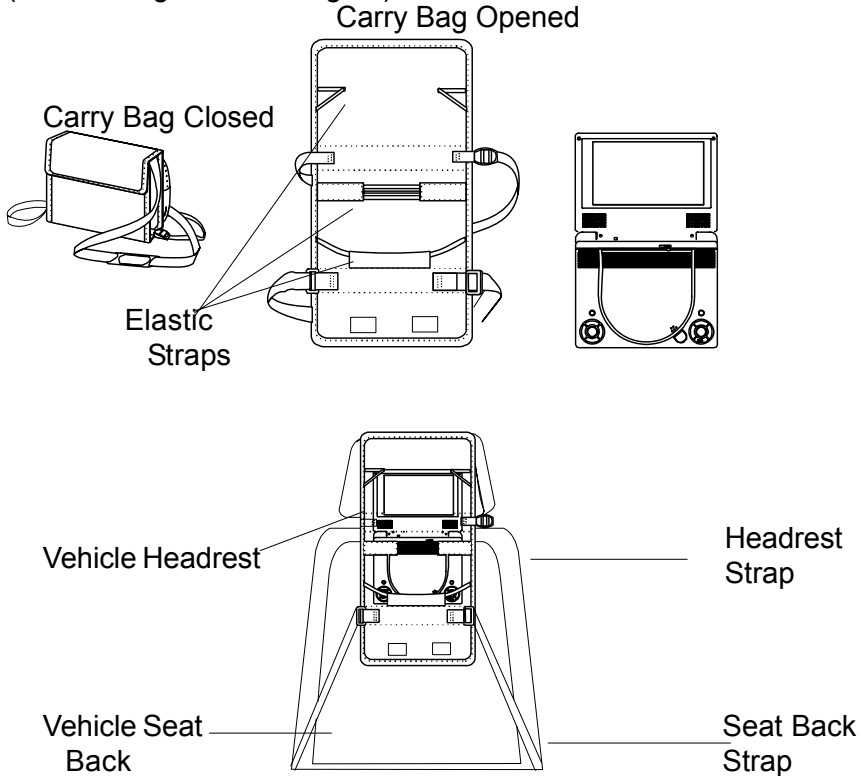

Figure 3

- 1). Unfold the carry bag, and place the DVD player on the bag beneath the elastic straps. Ensure that the unit's corners are secured by the elastic straps.
- 2). Secure the upper portion of the carry bag to headrest support bars using the headrest strap. Adjust the headrest strap until the bag is firmly secured.
- 3). Secure the lower portion of the carry bag to the vehicle seat back using the seat back strap. Adjust the seat back strap until the bag is firmly secured.

Installing the monitor

Option 1 Vehicle Headrest (Refer to Figure 4)

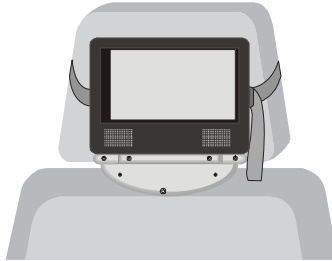

Figure 4

Slide the Monitor into the pouch and attach the Velcro straps to secure the Monitor in the pouch. Loop the strap of the pouch around the headrest and pull the end of the strap while holding the buckle to secure the pouch to the headrest.

Option 2 Flat Surface (Refer to Figure 5)



Figure 5

Rotate the base of Monitor backward and place on a flat surface. Adjust the screen for a proper viewing angle. This can be done with the Monitor inside or outside the pouch.

F. Controls, Indicators, and Connectors

1. Unit View (Refer to Figure 6)

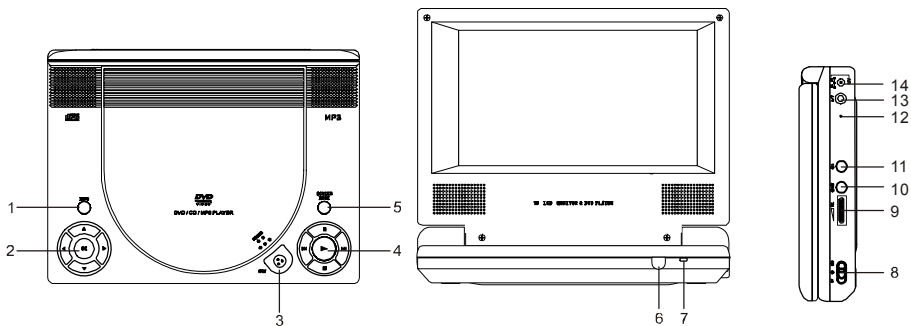

Figure 6

- | | |
|--|---------------------------|
| 1) Menu Button | 8) Power On/Off Switch |
| 2) Up/Down/Left/Right/OK Buttons | 9) Volume Up/Down Control |
| 3) Open Button | 10) Headphone Jack 1 |
| 4) Previous/Next/Pause/Stop/Play Buttons | 11) Headphone Jack 2 |
| 5) Screen Mode Button | 12) Charge Indicator |
| 6) Remote Sensor | 13) AV Out Jack |
| 7) Power Indicator | 14) DC Input Jack |

2. **Monitor View** (Refer to Figure 7)

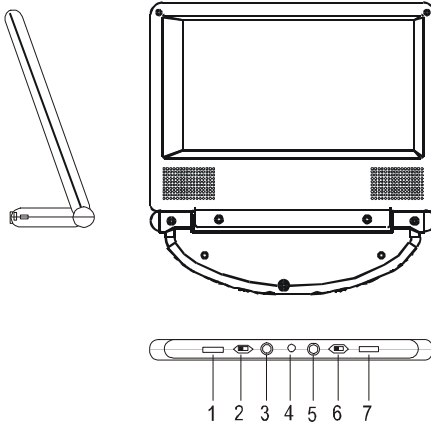

Figure 7

- 1). Volume Control
- 2). Reverse Switch
- 3). Headphone Jack
- 4). DC 9-12V Input Jack
- 5). AV In Jack
- 6). Power Off/On Switch
- 7). Brightness Control

NOTE: Slide the Reverse Switch to rotate the picture 180 degrees.

3. Remote Control View (Refer to Figure 8)

- 1) Setup Button
- 2) Up Button
- 3) Previous Button
- 4) Enter Button
- 5) Reverse Scan /Left Button
- 6) Down Button
- 7) Numeric Keypad
- 8) Display Button
- 9) Zoom Button
- 10) Subtitle Button
- 11) Next Button
- 12) A-B Repeat Button
- 13) Forward Scan /Right Button
- 14) 1/All Repeat Button
- 15) Stop Button
- 16) Menu Button
- 17) Audio Button
- 18) Angle Button
- 19) Play/Pause Button

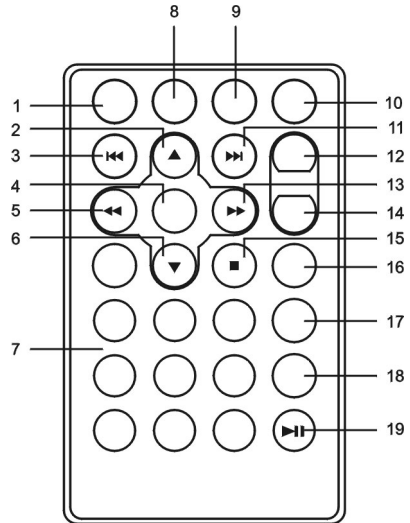

Figure 8

G. Loading and Playing a Disc

- a. After connecting power to the unit, apply power to the DVD player with the power switch. The power indicator will light.
- b. Open the disc tray by pressing OPEN button and place a disc into the tray with the label side facing up.
- c. Close the tray by pressing the "PRESS" button. The unit will load the disc and start playing.
- d. Rotate the VOLUME control to adjust the DVD player's volume.
- e. To stop playing a disc, press STOP.
- f. To turn off the DVD player, slide the POWER ON/OFF switch to OFF.

H. Setup

Press **SETUP** to display the Main screen of the **SETUP** Menu on the screen. Press **SETUP** again to exit the **SETUP** Menu and the unit will resume it's last playback mode.

1) Press **SETUP**, the " **GENERAL SETUP PAGE** " will display on screen.

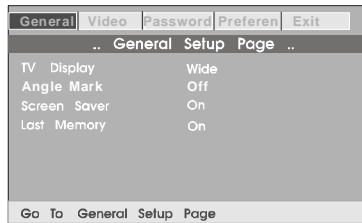

Main Setup Menu Screen

a).Select " **TV DISPLAY** " using the **DOWN** button, and then press **ENTER** to enter the submenu. Select the TV display mode on the screen using **UP/DOWN**, and press **ENTER** to confirm the setting. Press **LEFT** to return.

- * **NORMAL/PS**: When the player is connected to a normal TV, and a wide picture is shown on the full screen.
- * **NORMAL/LB**: When the player is connected to a normal TV, and a wide picture is shown on the screen with a black strip at both the top and bottom of the screen.
- * **WIDE**: When the player is connected to a wide screen TV, a wide picture is shown on the full screen.

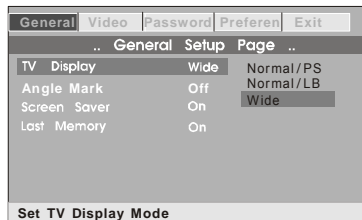

TV Display Screen Display

b).Select 'ANGLE MARK' using the DOWN button, and then press the 'ENTER' button to enter the submenu. Choose Angle Mark on or off using the UP/DOWN buttons and then press 'ENTER' to confirm the setting. Press the LEFT button to return.

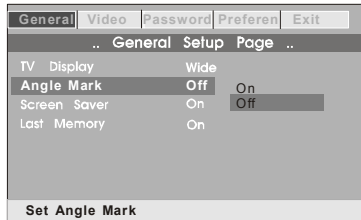

Angle Mark Screen Display

- * ON: The screen will show the angle mark icon. (*If an angle option is available).
- * OFF: The screen will not display the Angle Mark icon.

NOTE: Not all discs contain above features.

c). Select 'SCREEN SAVER' using the DOWN button.

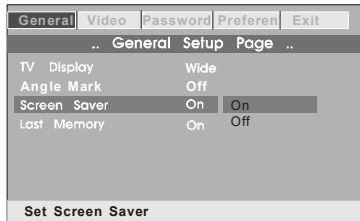

Screen Saver Screen Display

*ON: enables screen saver

*OFF: disables screen saver (off)

***NOTE:** The DVD player will enter the Screen Saver mode after approximately five minutes if the same image remains on the screen.

d). Select 'LAST MEMORY' by using the DOWN button.

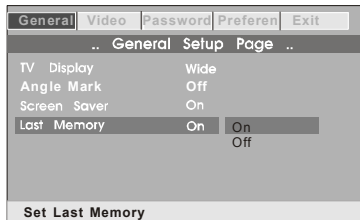

Last Memory Screen Display

*ON: The unit will return to the last position on the disc.

*OFF: The unit will not return to the last position on the disc.

2) Select 'VIDEO' by using the LEFT/RIGHT buttons, press 'ENTER' to enter the VIDEO SETUP PAGE.

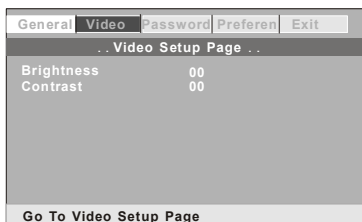

Video Quality Setup Screen Display

a).Select 'BRIGHTNESS' by using the UP or DOWN buttons ,then press 'ENTER'. Adjust the Brightness by pressing the LEFT or RIGHT buttons. To exit Brightness Setting, press 'ENTER' again to return to the VIDEO SETUP PAGE.

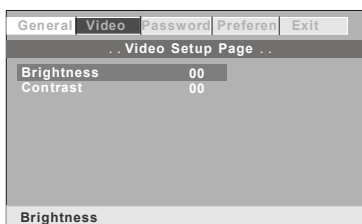

Brightness Screen Display

b).Select 'CONTRAST' by using the UP or DOWN buttons, then press 'ENTER'. Adjust the Contrast by pressing the LEFT or RIGHT buttons.

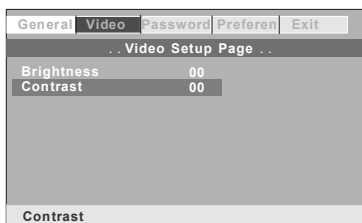

Contrast Screen Display

To exit Contrast setting, press 'ENTER' again to return to the VIDEO SETUP PAGE.

- 3). Select 'Password' using the LEFT or RIGHT buttons, then press the 'ENTER' button to enter the submenu.

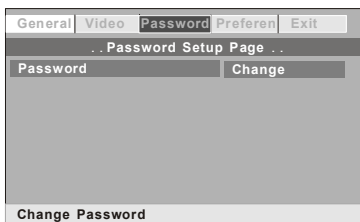

Password Setup Page Screen Display

Press 'ENTER' twice to enter the PASSWORD CHANGE PAGE. Input the Old Password or the Default Password, the New Password, and the Confirmed New Password. Press 'ENTER' to confirm the change.

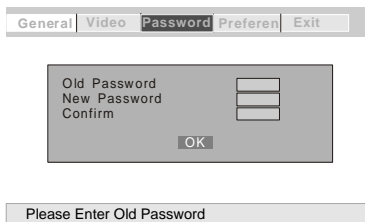

Password Change Page Screen Display

NOTE: The Default Password is **3308**. This password is always effective even after you have selected your own password and changed it. To avoid the possibility of others using the default password to set the parental level and change the password, you can record this default password in another area and delete it from this manual. Some discs can be limited depending on the age of users while some discs cannot.

4). With no disc inside the player select "PREFEREN" using the LEFT or RIGHT buttons, then press ENTER to enter the "PREFERENCES PAGE" .

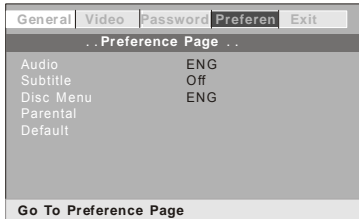

a). Select "AUDIO " using the DOWN button, then press ENTER to enter the submenu. Select the audio language you desire using the UP or DOWN buttons, then press ENTER to confirm the setting. Press LEFT to return.

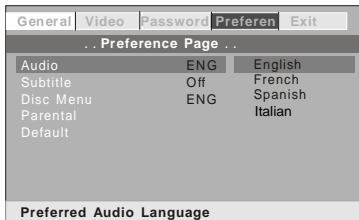

Preference Audio Language

- b). Select " SUBTITLE " using the DOWN button, then press ENTER to enter the submenu. Select the desired subtitle language or SUBTITLE OFF using the UP or DOWN buttons, then press ENTER to confirm the setting. Press LEFT to return.

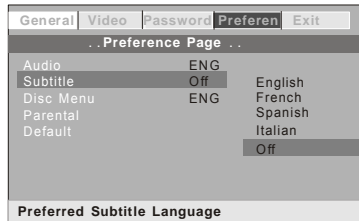

Preference Subtitle Language

- c). Select " DISC MENU " using the DOWN button, then press ENTER to enter the submenu. Select the Disc Menu Language you desire using the UP or DOWN buttons, then press ENTER to confirm the setting. Press LEFT to return.

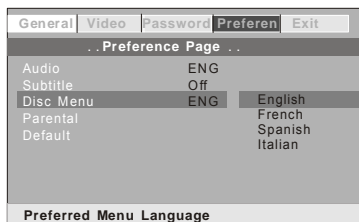

Preference Disc Menu Language Screen

NOTE: Language and subtitle selection is only available for discs that are recorded in the above listed languages. If the selected language is not available, the player will play and display on the screen the original recorded language contained in the disc.

- d). Select 'PARENTAL' using the DOWN button, then press 'ENTER' to enter the submenu.

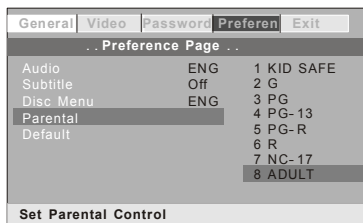

Parental Preference Screen Display

Select the parental level you desire using the UP or DOWN buttons for discs with lock-out function or multiple rating levels. These are listed from the lowest level (1 KID SAFE) to the highest level (ADULT). Enter a 4 digit password, then press 'ENTER' to confirm the parental level setting.

NOTE: The level of 8 ADULT is the factory default.

- e). Select 'DEFAULT' using the DOWN button, then press 'ENTER' to enter the submenu. Press 'ENTER' to make the setting return to the factory-set mode.

NOTE: The parental setting is not affected by the default reset function.

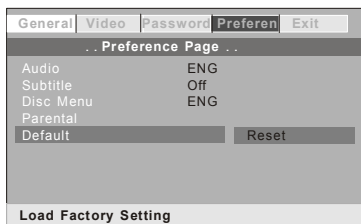

Loading Factory Setting

I. Basic Operation

POWER	Turn the unit on/off
OPEN	Remove/load the disc
PLAY	Start Play/Execute item or setting
PAUSE	Still Picture
STOP	(1 time) Stop at the present playing point / (2 times) Stop playing
NEXT	Go to the next chapter, track or scene during play back
PREVIOUS	Go back to the previous chapter, track or scene during play back
FORWARD	Scan forward at 2, 4, 8, 16 or 32x times speed
REVERSE	Scan backward at 2, 4, 8, 16 or 32x times speed
LEFT/RIGHT/UP/DOWN	Used for Menu Navigation
ENTER	Execute item or confirm setting
NUMBERS	Select item or setting
MENU	Display the main menu of the disc
REPEAT	Repeat playing title, chapter, or track
A-B	Repeat a specific portion from point A to point B of the disc
DISPLAY	Display information (title, chapter, track, time, etc.).
ANGLE	Change the viewing angles on the scene
SUBTITLE	Select the subtitle language and turn it on/off
AUDIO	Select the audio language
ZOOM	Enlarge an image to 2, 3, or 4 times the original size.
SETUP	Display the setup menu to select and set items, and exit the setup menu.

J. MENU

A DVD is divided into sections called titles and chapters. When you play a DVD, a root menu of the disc will appear on the screen of your TV or Monitor. The contents of the menu vary from disc to disc. Press 'MENU' during playback to display the menu. Some DVDs only allow you to select disc playback options using the DVD root menu.

K. DISPLAY *(Display contents vary from disc to disc.)*

1. PLAYING TIME AND REMAINING TIME

- a. During playback press the 'DISPLAY' button to display the current Title Number (1), the total Number of Titles (2), the current Chapter Number (3), the total Number of Chapters (4), and the elapsed playing Time for the title (5). The heading will disappear automatically after 3 seconds if no buttons are pressed.

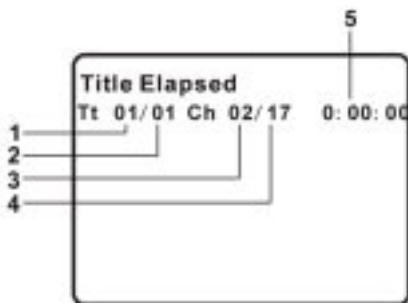

Title, Chapter Number and Time Screen Display

- b. Press 'DISPLAY' again to display the Remaining Time of the title. The heading will disappear automatically in 3 seconds.

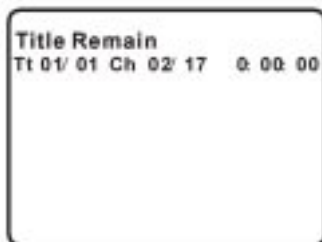

Title Remaining Time Screen Display

- c. Press 'DISPLAY' a third time to display the Elapsed Time for the chapter. The heading will disappear automatically in 3 seconds.

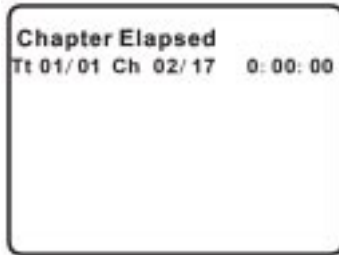

Chapter Elapsed Time Screen Display

- d. Press 'DISPLAY' a fourth time to display the Remaining Time for the chapter. The heading will disappear automatically in 3 seconds.

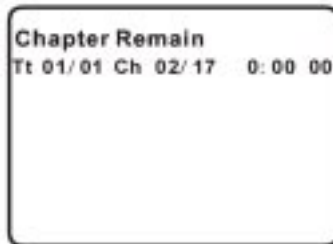

Chapter Remaining Time Screen Display

- e. Press 'DISPLAY' a fifth time to exit, 'DISPLAY OFF' will be displayed and will disappear automatically in 3 seconds.

2. ANGLE

During playback of a disc, press 'ANGLE' to display the available angles for discs containing multi-angles*, with the current angle number (1) and the total number of angles (2) displaying. Press 'ANGLE' to select another angle, then press again to exit and return to the normal viewing angle. The angle display will disappear automatically if the 'ANGLE' button is not pressed again within 3 seconds.

***NOTE:** Not all discs contain this feature.



Angle Screen Display

3. SUBTITLE

During disc playback press 'SUB' to select the subtitle language you desire*, with the current Subtitle Language Number (1) and the total Number of Subtitle Languages (2) displayed. If there are multiple languages press 'SUB' again to select another subtitle language. To turn subtitles OFF, press the 'SUB' button until 'SUB OFF' is displayed. The Subtitle display will disappear automatically if the 'SUB' button is not pressed again within 3 seconds.

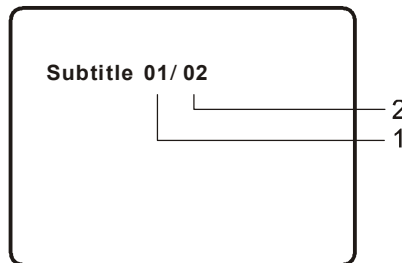

Subtitle Screen Display

* Some DVDs only allow access to this function through the DVD menu.

4. AUDIO

During playback press 'AUDIO' to select the audio language you desire*, with the current Audio Channel Number (1) and the total number of Audio Channels (2) displayed. Press AUDIO again to select another audio language. The audio display will disappear automatically if the 'AUDIO' button is not pressed within 3 seconds.

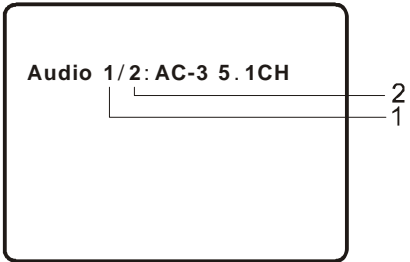

Audio Language Screen Display

* Some DVDs only allow access to this function through the DVD menu.

5. ZOOM

During playback press 'ZOOM' to enlarge the picture by 2x, 3x or 4X with the current zoom multiple. (1) Press "zoom" one time, the picture will be enlarged 2X. (2) Press "zoom" a second time, the picture will be enlarged 3X. (3) Press "zoom" a third time, the picture will be enlarged 4X. (4) Press "zoom" a fourth time, the picture will return to normal size.

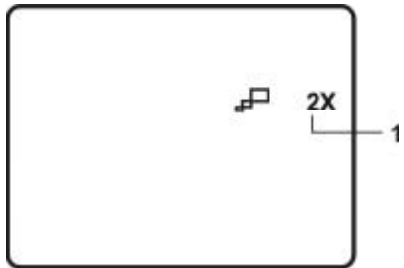

ZOOM Screen Display

6. A-B REPEAT

- a. During playback press 'A-B' to set the Starting Point A.

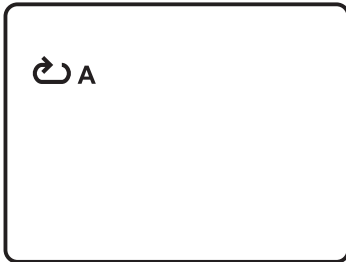

A-B Repeat Starting Point Screen Display

- b. Press 'A-B' a second time to set the Ending Point B and the player will repeatedly play the part between Point A and Point B.

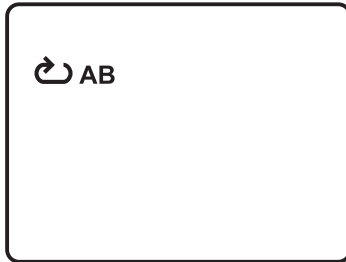

A-B Repeat Ending Point Screen Display

- c. Press A-B a third time to cancel A-B repeat and resume playback.

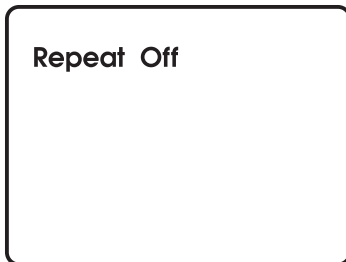

A-B Repeat Cancelled Screen Display

7. REPEAT

- a. During playback press '1/ALL' once to repeatedly play the current chapter.

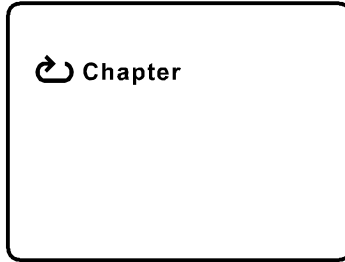

Chapter Repeat ON Screen Display

- b. During playback press '1/ALL' again to repeatedly play the current title.



Title Repeat ON Screen Display

- c. During playback press '1/ALL' a third time to repeat all Chapters and Titles.

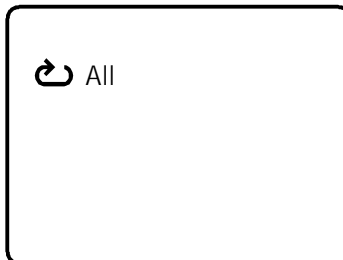

All Repeat ON Screen Display

d. Press '1/ALL' a fourth time, to resume normal play.

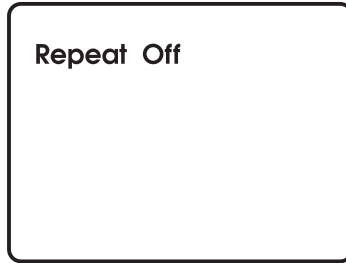

Repeat Off Screen Display

8. FORWARD/REVERSE SCAN

- a. During playback press ►► to scan forward at 2x, 4x, 8x, 16x, 32x and normal speed.
- b. During playback press ◀◀ to scan forward at 2x, 4x, 8x, 16x, 32x and normal speed.

L. PLAYING AUDIO CDS

When an CD disc is inserted into the unit, the Menu Screen appears. You can use Up and DOWN button to choose the song you desired. Press ENTER to play.

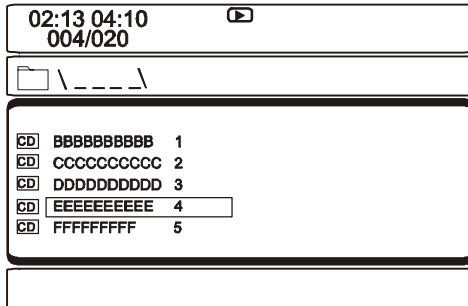

Menu Screen

1. USING THE REPEAT FEATURE

The default mode for the Repeat feature is OFF. Pressing '1/ALL' consecutively changes the repeat options:

- *Repeat one-* repeats the track that is playing.
- *Repeat All-* repeats the disc that is playing.
- *Repeat Off*

As you toggle through the options, the repeat option changes. The selected repeat option loops repeatedly until you turn it off.

2. A-B REPEAT

- During playback press 'A-B' to set the Starting Point A.
- Press 'A-B' a second time to set the Ending Point B and the player will repeatedly play the part between Point A and Point B.
- Press A-B a third time to cancel A-B repeat and resume playback.

3. FORWARD/REVERSE SCAN

- During playback press ►► to scan forward at 2x, 4x, 8x, 16x, 32x and normal speed.
- During playback press ◀◀ to scan forward at 2x, 4x, 8x, 16x, 32x and normal speed.

M. PLAYING MP3 DISCS

MP3 is a format for storing digital audio. An audio CD-quality song is compressed into the MP3 format with very little loss of audio quality while taking up much less disc space. CD-R /RW discs that have been encoded in MP3 format are compatible with this system.

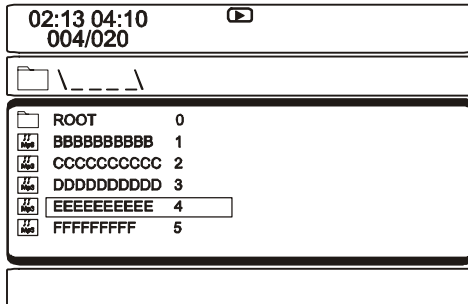

Menu Screen Display

When an MP3 disc is inserted into the unit, the Menu Screen appears automatically. You can use the Menu Screen to change folders and songs. The system plays the songs in the order they were burned onto the disc.

1. Press the ▲ or ▼ button to choose a folder from the folder list.
2. Press ENTER to select the highlighted folder. The songs available under the folder will be listed.
3. Use ▲ or ▼ button to choose a song from the list. Press ENTER to select and begin playback of the highlighted song.
4. Use the ►► (NEXT) button to move to the next song. Press the ◀◀ (PREVIOUS) button to move to the beginning of the previous song.

1. USING THE REPEAT FEATURE

The default mode for the Repeat feature is OFF. Pressing '1/ALL' consecutively changes the repeat options:

- *Repeat one*- repeats the track that is playing.
- *Repeat Folder*- repeats the disc that is playing.
- *Repeat Off*

As you toggle through the options, the repeat option changes. The selected repeat option loops repeatedly until you turn it off.



2. A-B REPEAT

- a. During playback press 'A-B' to set the Starting Point A.
- b. Press 'A-B' a second time to set the Ending Point B and the player will repeatedly play the part between Point A and Point B.
- c. Press A-B a third time to cancel A-B repeat and resume playback.

3. FORWARD/REVERSE SCAN

- a. During playback press ►► to scan forward at 2x, 4x, 8x, 16x, 32x and normal speed.
- b. During playback press ◀◀ to scan backward at 2x, 4x, 8x, 16x, 32x and normal speed.

NOTE

- “” icon in front of a file name indicates that this is a folder, not an MP3 file.
- “” icon in front of a file name indicates that this is a MP3 file.

N. Playing JPEG files

- 1) Load the JPEG Disc into tray.
- 2) The pictures contained will be displayed automatically after loading.
- 3) You can view the picture you selected by pressing "SKIP+" or "SKIP" buttons.
- 4) Press the "Down" button to rotate the picture Clockwise.
- 5) Pressing the ZOOM button and the image will enlarge picture 125%, 150%, 200% or zoom out by 75%, 50% the original size. When the image is enlarged, you may use the navigation buttons to view blocked parts of the picture.
- 6) While viewing the file, pressing "SUBTITLE", "AUDIO" or "AB" will result in an icon will appearing on the display indicating that these options are not available.

O. Connecting to Other Equipment

1. AV Out

Connecting to a TV or another monitor (Refer to Figure 9)

Connect one end of the supplied AV cable (one to three Male) (1/8") plug into the unit's DVD's AV Out jack, and connect the other end to the AV INPUT jacks on your TV or Monitor (white=left channel, red=right channel, yellow= video).

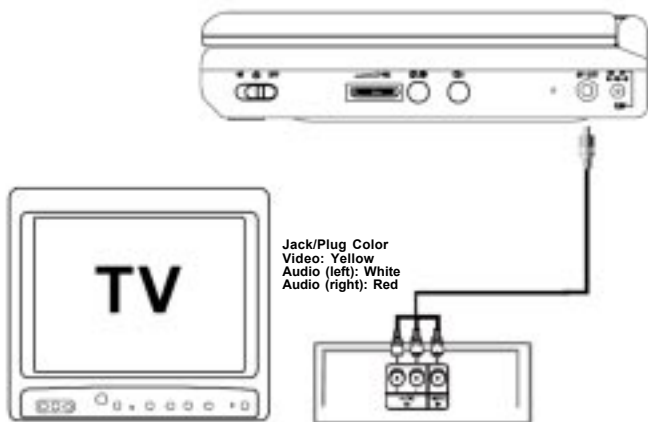

Figure 9

2. Connecting Optional Headphones

Simply plug the optional headphones into either Headphone jack 1 or Headphone jack 2 on the right side of the DVD Player. (Refer to Figure 10)

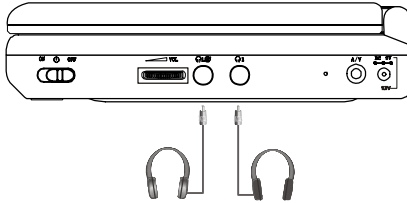

Figure 10

Plugging into Headphone jack 1 will disable the internal speakers.

P. Specifications

Compatible DISC: DVD/CD/MP3

Signal system: NTSC

Panel size: 7 inch

DVD video format: Horizontal 720 pixel, vertical 480 pixel (NTSC)

Frequency response: 20 Hz to 20 kHz

Video output: 1 V_{p-p}/75 Ohm, unbalanced

Audio output: 1.4V_{rms}/10kOhm

Audio S/N: Better than 60 dB

Dynamic range : Better than 85 dB

Laser: Semiconductor Laser, Wave Length: 650 nm/795 nm

Power source: DC 9~12V

Power consumption: 12 W
Operating temperature: 41~95°F (5~35°C)
Weight : 1.48lbs (0.67 kg)
Dimensions (W x D x H):7.87 X 5.92 X 1.44 inches
(200 x 150.5 x 36.5mm)
Battery Type: Li-Polymer

Single Monitor

Signal system:	NTSC
Panel size:	7 inch
Resolution:	480 x 234
Power source:	DC 9~12V
Power consumption:	6W,0.5 Amp
Operating temperature:	41~104°F (5~40°C)
Operating humidity:	10-75%
Storage temperature	4~140°F (-20~60°C)
Weight : 0.72lbs (0.327 kg)	
Dimensions (W x D x H):	8.0" X 5.94" X 0.47" (204 x 151 x 12 mm)

Q. Built-In Rechargeable Battery

The DVD player utilizes a long-life Li-Polymer battery for portability. Li-Polymer batteries feature high storage capacity and low level of degradation. This means the Li-Polymer batteries do not have “Memory Effect” and thus can be recharged regardless of whether the battery is fully or only partially discharged. **The battery must be charged at least 8 hours prior to first use.**

NOTE: If you plan not to use the battery for an extended period of time (one week or longer), we recommend that you fully charge the battery. For longer periods of storage, please recharge the battery at least once every two months to maintain the battery in optimum condition. Each full recharge takes approximately five hours and one full charge can provide power to the player for approximately 2 hours. During recharge, the red indicator will stay on. Once fully recharged, the red light will turn off. At this point you may remove the wall plug and stop charging.

Precautions related to Battery Recharge:

1. The DVD player must be set to power off
2. Once the battery is fully discharged, immediately recharge (regardless of whether you plan to use battery or not) in order to maximize battery life.
3. To charge the battery, please connect the power jack directly into the DVD Player and leave connected until the red charge indicator turns off.

Using and Maintaining your Rechargeable Batteries

1. Please make sure you always use **only** the AC adapter included with the player to recharge your batteries. The battery can only be charged with the AC adaptor and will **NOT** charge with the car DC adaptor.
2. Recharge efficiency will degrade when environmental temperatures drop below 50°F (10°C) or exceed 95°F (35°C).



AUDIOVOX
ELECTRONICS CORP.

90 DAY LIMITED WARRANTY

Applies to Audiovox Video Products

AUDIOVOX ELECTRONICS CORP. (the Company) warrants to the original retail purchaser of this product that should this product or any part thereof, under normal use and conditions, be proven defective in material or workmanship within 90 days from the date of original purchase, such defect(s) will be repaired or replaced with reconditioned product (at the Company's option) without charge for parts and repair labor. A game controller, if supplied, is similarly warranted for ninety (90) days.

To obtain repair or replacement within the terms of this Warranty, the product is to be delivered with proof of warranty coverage (e.g. dated bill of sale), specification of defect(s), transportation prepaid, to the Company at the address shown below.

This Warranty does not extend to the elimination of externally generated static or noise, to correction of antenna problems, to costs incurred for installation, removal or reinstallation of the product, or to damage to digital memory/media devices, gaming devices, discs, speakers, accessories, or electrical systems.

This Warranty does not apply to any product or part thereof which, in the opinion of the Company, has suffered or been damaged through alteration, improper installation, mishandling, misuse, neglect, accident, or by removal or defacement of the factory serial number/bar code label(s). THE EXTENT OF THE COMPANY'S LIABILITY UNDER THIS WARRANTY IS LIMITED TO THE REPAIR OR REPLACEMENT PROVIDED ABOVE AND, IN NO EVENT, SHALL THE COMPANY'S LIABILITY EXCEED THE PURCHASE PRICE PAID BY PURCHASER FOR THE PRODUCT.

This Warranty is in lieu of all other express warranties or liabilities. ANY IMPLIED WARRANTIES, INCLUDING ANY IMPLIED WARRANTY OF MERCHANTABILITY, SHALL BE LIMITED TO THE DURATION OF THIS WRITTEN WARRANTY. ANY ACTION FOR BREACH OF ANY WARRANTY HEREUNDER INCLUDING ANY IMPLIED WARRANTY OF MERCHANTABILITY MUST BE BROUGHT WITHIN A PERIOD OF 24 MONTHS FROM DATE OF ORIGINAL PURCHASE. IN NO CASE SHALL THE COMPANY BE LIABLE FOR ANY CONSEQUENTIAL OR INCIDENTAL DAMAGES FOR BREACH OF THIS OR ANY OTHER WARRANTY, EXPRESS OR IMPLIED, WHATSOEVER. No person or representative is authorized to assume for the Company any liability other than expressed herein in connection with the sale of this product.

Some states do not allow limitations on how long an implied warranty lasts or the exclusion or limitation of incidental or consequential damage so the above limitations or exclusions may not apply to you. This Warranty gives you specific legal rights and you may also have other rights which vary from state to state.

U.S.A. : AUDIOVOX ELECTRONICS CORPORATION, 150 MARCUS BLVD, HAUPPAUGE, NEW YORK 11788
● 1-800-645-4994

CANADA : CALL 1-800-645-4994 FOR LOCATION OF WARRANTY STATION SERVING YOUR AREA

© 2007 Audiovox Electronics Corporation

128-5556G

